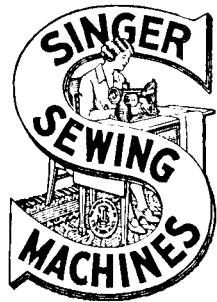


SINGER
47W120

LIST OF PARTS



MACHINE No. 47w120

THE SINGER MANUFACTURING COMPANY

INDEX

	PAGE
ACCESSORIES	14
BOBBIN WINDER	14
KNEE LIFTER	15
MACHINE No. 47w120	7
NUMERICAL LIST OF PARTS	17

From the library of: Diamond Needle Corp

Instructions for Ordering

In ordering from this list, use **ONLY** the **PART** number in the **FIRST** column.

The number stamped on a Sewing Machine Part is the number of the Single Part only, except when the part includes Set Screws, Clamping Screws, Studs and Rollers Spun on, Small Wires riveted, or Parts soldered together, etc., which it is necessary to furnish in combination.

Every combination of parts sent out has its specific number which, although not stamped on Parts (except in above case), must be used when ordering the combination.

Each number always indicates the **SAME PART** in whatever list it appears, or for whatever Machine.

The letters after some of the numbers indicate the style of finish only, as follows:

- A. Hardened, Polished and Plated.
- B. Polished and Plated.
- C. Hardened only.
- D. Polished only.
- E. Soft, not polished.
- F. Hardened and Polished.
- H. Blued.

These letters **MUST BE USED** when they appear in the list and **AFTER** the number, as in the list.

In this series

- 200001 to 201500 are Screw Numbers.
- 201501 to 201800 are Nut Numbers.
- 201801 to 202000 are Roller Numbers.
- 202001 and upward are Numbers of Machine Parts.

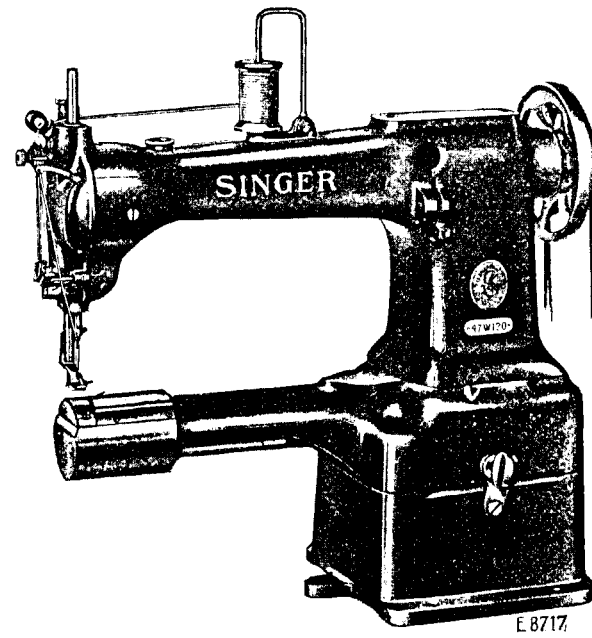
The figures in the second column refer only to the plate in which the illustration of the part is shown and are **NOT TO BE USED** in ordering.

Two or more numbers over a cut indicate that the difference between such parts is not visible in an illustration.

Parts marked with an asterisk (*) are furnished only when repairs are made at the factory.

LIST OF PARTS COMPLETE

FOR



MACHINE No. 47w120

CYLINDER BED. NO FEED MOTION.

KNEE LIFTER

For General Darning

No.	Plate	Name
*213361	—	Arm
213144	15214	" Cap
200278H	12311	" " Screw
202248	15213	" " " Washer
204235	15213	" Position Pin
200963E	12311	" Screw (3)
202005	15213	" " Washer (3)
213341	15215	" Shaft
204801	15214	" " Bushing (back) with 202260

From the library of: Diamond Needle Corp

No.	Plate	Name
202260	—	Arm Shaft Bushing (back) Oil Packing (wick)
200338c	15213	Arm Shaft Bushing (back) Set Screw
213299	15214	Arm Shaft Bushing (center) with 202260
202260	—	Arm Shaft Bushing (center) Oil Packing (wick)
200341c	15213	Arm Shaft Bushing (center) Set Screw
213781	15214	Arm Shaft Bushing (front) with 202036 and 202260
202260	—	Arm Shaft Bushing (front) Oil Packing (wick)
200502B	15213	Arm Shaft Bushing (front) Oil Packing Thumb Screw
202036	15213	Arm Shaft Bushing (front) Position Pin
200352c	15213	Arm Shaft Bushing (front) Set Screw
204804	15214	Arm Shaft Connection with four 200054E (2)
200054E	15213	Arm Shaft Connection Screw
204805	15215	Balance Wheel, 5½ in. diam. (belt groove 2¾ in. diam.), with 200328c and 200335c
200062H	12311	Balance Wheel Adjusting Screw ..
200328c	12311	" " Position Screw
200335c	12311	" " Set Screw
*213377	—	Bed (cylinder) with 201461c, 213314, 213380 and two 200516E
*213786	—	Bed (cylinder) Cap (use 221188 for repairs)
221188	15214	Bed (cylinder) Cap with two each 200100D and 222404
222404	15213	Bed (cylinder) Cap Position Pin ..
200100D	15213	" " " Screw
200574D	15213	" " " " (2)
213787	—	" " End Cover
213353	—	" " Base (6 in. high)
213890	—	" " (4 in. high)
		Note. High Bed Base 213353 furnished only when ordered.
203184	15213	Bed Clamp
200262H	15213	" " Hinge Screw
202622	15213	" " Packing Washer
200728B	15213	" " Thumb Screw
203185	15213	" " Washer

No.	Plate	Name
202618	15215	Bed Hinge
200030H	15213	" " Screw (6)
213338	15214	" Slide (back)
213685	15213	" " Clamp Plate
213686	15213	" " " "
200582H	15213	" " " " Screw (4) ..
203208	11228	Bobbin
203210	11228	" Case Base with 202056, 203211 to 203213 and 203216
203211	15213	Bobbin Case Base Latch
*202056	—	" " " " Pin
203212	15213	" " " " Plunger ..
203213	15213	" " " " Spring ..
203209	11228	" " Cap with 200984c, 203214, 203215 and two 200594c ..
203214	11228	Bobbin Case Tension Spring
200984c	11228	" " " " Regulating Screw
200594c	11228	Bobbin Case Tension Spring Screw
203215	11228	" " Thread Guide
200594c	11228	" " " " Screw ..
203216	11228	" " Washer (cloth)
203217	11228	Bobbin Case complete, Nos. 203209 and 203210
204184	15215	Face Plate with 200355H, 200368H, 200688c, 202090, 204185, 204281 and two 200397H
200053c	12311	Face Plate Screw
204185	15213	" " Thread Guide
200397H	12309	" " " " Set Screw
204186	—	Face Plate complete, Nos. 200135E, 200309E, 200319c, 200577H, 204059, 204184, 204267, 204272 and 204277 to 204280
*203239	—	Hook (sewing)
203240	11228	" 203239 with 201253F, 201376F and 203251
203290	11228	Hook and Bobbin Case complete, Nos. 203217 and 203240
203549	15213	Hook Bevel Gear Socket, 18 teeth
200556H	15213	" " " " Screw ...
213319	15213	" " Pinion with two 200386c
200386c	15217	" " " Set Screw
221172	15215	" Driving Shaft
213314	15214	" " " Bearing
202126	15217	" " " " Position Pin (2)

No.	Plate	Name
200516E	12311	Hook Driving Shaft Bearing Screw
213380	15214	" " " Bushing
201461c	15217	" " " " Position Screw
204246	15217	Hook Driving Shaft Collar (back) with two 200383c
200383c	15217	Hook Driving Shaft Collar (back) Set Screw
203244	15217	Hook Driving Shaft Collar (front) with two 200393c
200393c	15217	Hook Driving Shaft Collar (front) Set Screw
203251	11228	Hook Gib
201376F	15217	" " Hinge Screw
201253F	15217	" " Screw
203552	15216	" Saddle (right) with 202299 ..
202299	—	" " Oil Packing (wick) ...
200541E	15217	" " Screw (2)
225837	15217	" " " Washer (2)
203254	11228	" Washer
203554	—	Hook Saddle (right) complete, Nos. 200556H, 203254, 203290, 203549 and 203552
202781	15215	Knee Lifter Lifting Lever
227306	—	" " " " 202781 with 200262H
200262H	15213	Knee Lifter Lifting Lever Hinge Screw
221145	15216	Knee Lifter Lifting Lever Position Spring (right)
200835D	15217	Knee Lifter Lifting Lever Position Spring Screw
208613	15216	Needle Bar (hollow)
204247	—	" " 208613 with 200125F, 200175D and 204250
204248	15217	Needle Bar Connecting Link
200658c	15217	" " " " Hinge Screw Stud
201519E	15217	Needle Bar Connecting Link Hinge Screw Stud Nut
204249	15217	Needle Bar Connecting Stud with 200072c and 202277
202277	—	Needle Bar Connecting Stud Oil Packing (wick)
200072c	15217	Needle Bar Connecting Stud Pinch Screw

No.	Plate	Name
204326	—	Needle Bar Packing Cord (2)
200504E	15217	" " Screw Bushing (lower)
200503B	15217	" " " " (upper)
204250	15217	" " Thread Guide
200175D	15217	" " " " Screw ..
200125F	15217	" Set Screw
204251	15216	Presser Bar (hollow) with 200074F
204252	10441	" " Lifter
200550c	10441	" " " Hinge Screw ...
204255	10441	" " Lifting Bracket with 200086c
200086c	10441	Presser Bar Lifting Bracket Pinch Screw
204254	10441	Presser Bar Lifting Bracket Posi- tion Guide
200362c	10441	Presser Bar Lifting Bracket Posi- tion Guide Set Screw
204327	—	Presser Bar Packing Washer (felt)
200504E	15217	" " Screw Bushing (lower)
204255	—	" " Spring
200491B	10441	" " Thumb Screw (pres- sure regulating)
221193	15218	Presser Foot
200074E	10441	" " Screw
202068	15216	Spool Holder Base
200575H	12311	" " " Screw
204296	15216	" " Wire
200079H	12311	" " " Hinge Screw ...
204297	15216	Spool Holder complete, Nos. 200079H, 202068 and 204296
212920	15216	Take-up Cam with 200335c and 200430c
203268	—	Take-up Cam 212920 with 200383c, 200658c and 201519E
203172	15217	Take-up Cam Friction Washer ...
200430c	12311	" " Position Screw
200383c	15217	" " " " Check Screw
200335c	12311	Take-up Cam Set Screw
204262	15217	" Lever
206556	—	" " 204262 with 204263 ...
204263	15217	" " Bearing with 204264..
204264	15217	" " " Position Pin ...
200042F	12311	" " " Screw
201816	15217	" " Roller
204266	—	Take-up Lever complete, Nos. 200042F, 201816 and 206556

No.	Plate	Name
244007	12309	Tension Disc
202090	15217	" " Position Pin
204267	15217	" Release Lever
200688C	15217	" " " Position Screw
200309E	12309	" " " Screw
202075	12309	" " Plunger
208489	15218	" " Slide
206608	15217	" " " Spring
202407	10881	" Spring
200632B	12309	" Stud
200397H	12309	" " Set Screw
201572B	10881	" Thumb Nut
204271	12309	" Washer
204272	12309	Tension complete, Nos. 200632B, 201572B, 202075, 202407, 204271 and two 244007
204273	15217	Thread Controller Adjusting Collar with 200684H (for Presser Bar)
200684H	15218	Thread Controller Adjusting Collar Screw
204274	12309	Thread Controller Plate
200577H	12311	" " " Screw
202098	12309	" " Roller
204275	12309	" " " Guard
202084	15218	" " " " Washer
200300C	12309	" " " Screw
204276	12309	" " Spring
204333	12309	" " " Guard
200581H	12309	" " " " Screw
204277	12309	" " " Stop
204278	12309	" " " " Driving Gear
200319C	12309	Thread Controller Spring Stop Driving Gear Hinge Screw
200135E	12309	Thread Controller Spring Stop Screw
204279	12309	Thread Controller Spring Stud with 204925
200355H	15218	Thread Controller Spring Stud Set Screw
204925	15218	Thread Controller Spring Stud Washer
205987	12309	Thread Controller complete, Nos. 200300C, 200581H, 202084, 202098, 204274, 204275 and 204333
204280	12309	Thread Controller and Spring com- plete, Nos. 204276 and 205987 ..

No.	Plate	Name
202413	15218	Thread Guide
204281	12309	" Retainer Guide Wire
202091	12309	" " Sleeve
202092	12309	" " Spring
204058	12309	" " Stud
200368H	12309	" " " Set Screw
204059	12309	Thread Retainer complete, Nos. 202091, 202092 and 204058
221194	15218	Throat Plate, 40 needle hole, for needle sizes 16 and 18
200577H	12311	Throat Plate Screw (2)

ACCESSORIES

No.	Plate	Name
203208	11228	Bobbin (5)
*225482	—	" Case Screw Driver Blade ..
*225483	—	" " " " Handle ..
225497	14154	Bobbin Case Screw Driver complete, Nos. 225482 and 225483 ..
204033	15218	Wrench
126 x3	—	Needles, six, size 18
227104	—	Drip Pan with one wood screw 1½ in., No. 14
41401	14154	Machine Rest Pin (wood)
120342	14154	Oiler (copper plated) with 120343
120343	14154	" Spout, 3½ in. long
*225484	—	Screw Driver Blade
*225485	—	" " Handle
225498	14154	Screw Driver complete (7¼ in. long), Nos. 225484 and 225485 ..
225554	14154	Wrench (steel)

BOBBIN WINDER

Swing Automatic, Right Hand

225453	10884	Frame with 202277 and 225438 ...
225454	10884	" Hinge Pin
202277	—	" Oil Packing (wick)
225438	10884	" " Well Cap
225455	10884	" Spring
225456	10884	" " Plunger
202473	10885	Pulley with 200380c
200380c	15218	" Set Screw
225381	10884	Spindle
225444	10884	Stop Latch
200056E	10884	" " Screw
225458	10884	" " Thumb Lever
225459	10884	" " " " Hinge Stud
225459	10884	" " " " Joint Stud
202478	10884	" " Trip Lever
200299H	10884	" " " " Hinge Screw
225461	10881	Tension Bracket with 201499B
200082D	10881	" " Screw
228026	10884	" " " Washer
2102	10881	" Disc
202407	10881	" Spring
201499B	10881	" Stud
201572B	10881	" " Thumb Nut

No.	Plate	Name
225462	10881	Bobbin Winder Tension Bracket complete, Nos. 201572B, 202407, 225461 and two 2102
225433	10885	Bobbin Winder and Tension Bracket Base
225382	10885	Universal Bobbin Winder complete, Nos. 200056E, 200082D, 200299H, 202473, 202478, 225381, 225433, 225444, 225453 to 225456, 225458, 225462, 228026 and two each 225459 and wood screws ¾ in., No. 12, R.H.B.

KNEE LIFTER

227626	15219	Lifting Lever Chain Spring
227471	—	" " " " 227626 with 202784
202784	15219	Lifting Lever Chain Spring Hook ..
2763	15219	Rock Shaft
12242	15219	" " Hanger (back) with two wood screws 1 in., No. 10 ..
21327	15219	Rock Shaft Hanger (front) with two wood screws 1 in., No. 10 ..
6337	15219	Rock Shaft Lifting Bracket with two 356c
39811	15219	Rock Shaft Lifting Bracket Extension with 39576
356c	15219	Rock Shaft Lifting Bracket Extension Set Screw
356c	15219	Rock Shaft Lifting Bracket Set Screw
227676	15219	Rock Shaft Lifting Chain with 202784
39576	15219	Rock Shaft Lifting Chain Hook (lower)
202784	15219	Rock Shaft Lifting Chain Hook (upper)
228562	15219	Rock Shaft Knee Arm
2766	15219	" " " " Hub with 356c
356c	15219	Rock Shaft Knee Arm Hub Set Screw
1507R	15219	Rock Shaft Knee Arm Lock Nut
228563	—	Knee Lifter Rock Shaft Knee Arm complete, Nos. 1507R, 2766, 2767 and 228562

No.	Plate	Name
2767	15219	Rock Shaft Knee Plate with 356c..
228255	15219	" " " " Counter Balance Spring
356c	15219	Rock Shaft Knee Plate Set Screw
2770	15219	" " Stop Dog with 356c ...
356c	15219	" " " " Set Screw ..
228251	15219	Knee Lifter Rock Shaft complete, Nos. 2763, 6337, 12242, 21327, 39811, 227676, 228255, 228563, Form A 1079 and two 2770

(Other Knee Lifter parts are listed with parts of machine head.)

PLATE 10441—FULL SIZE

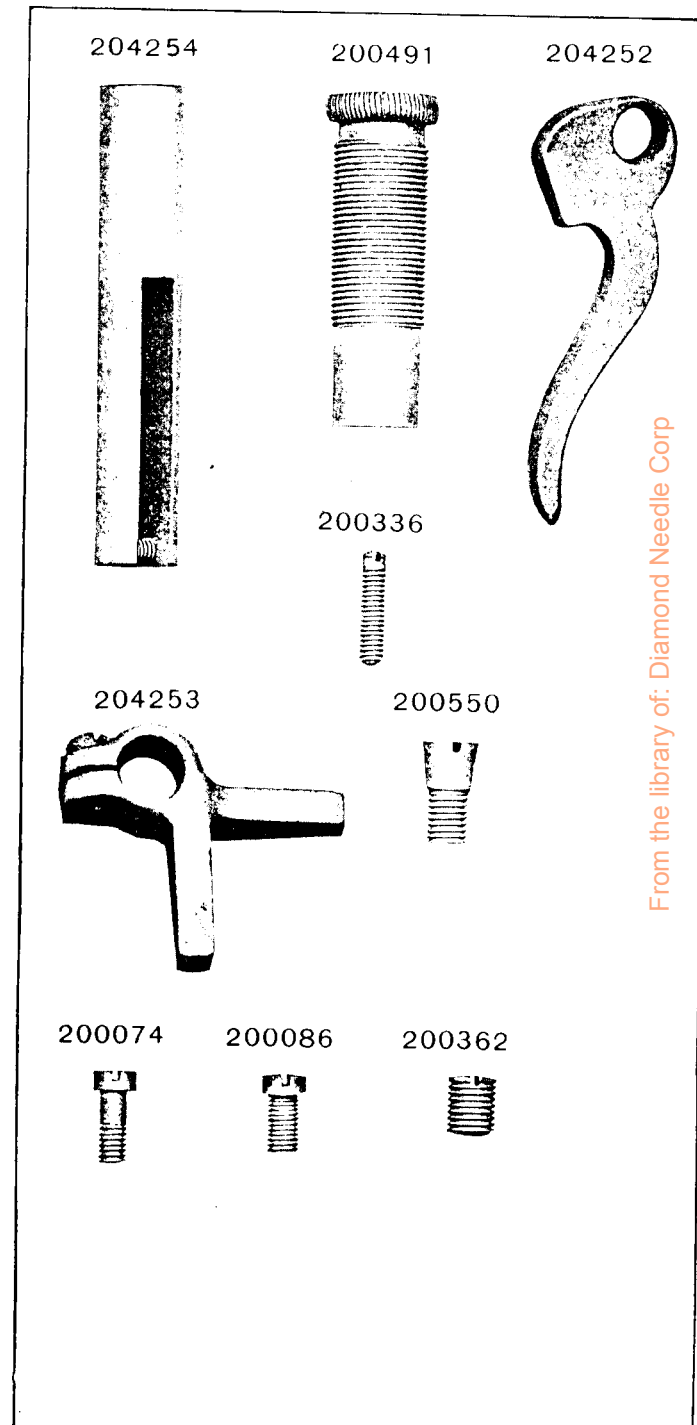
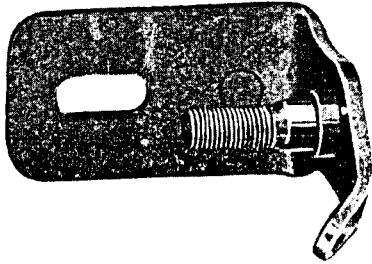


PLATE 10881—FULL SIZE

225461



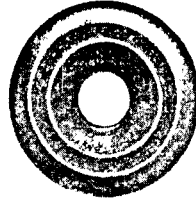
200082



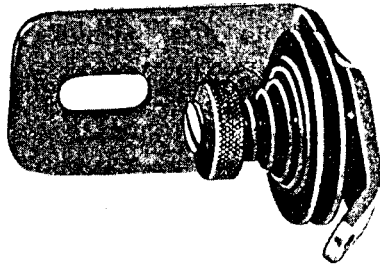
202104



2102



225462



202407



201499

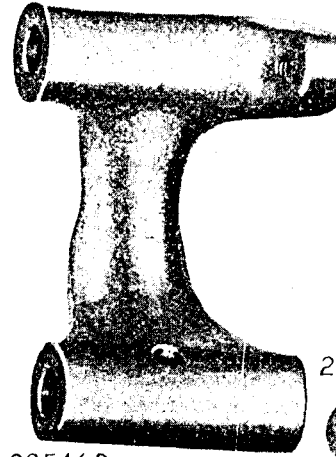


201572

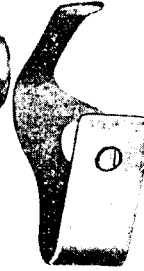


PLATE 10884—FULL SIZE

225453



225444



202478



228026



225458



225460



225454



200299



225438



200056



225459



200105



225456



225381



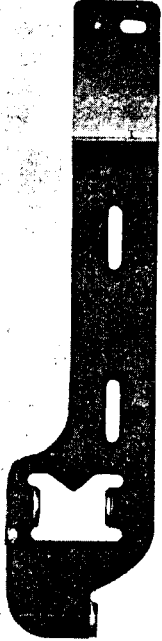
225455



From the library of: Diamond Needle Corp

PLATE 10885-ONE-FOURTH SIZE

225433



202473

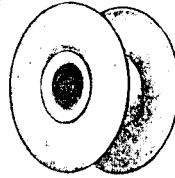


225382



PLATE 11228-FULL SIZE

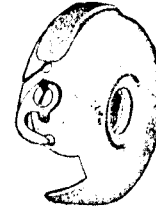
203208



203214



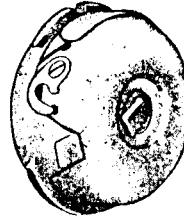
203209



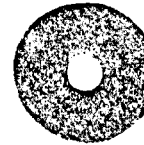
203215



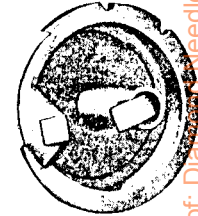
203217



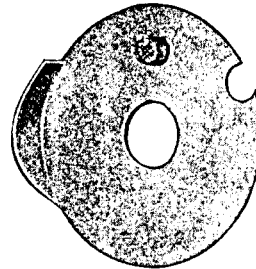
203216



203210



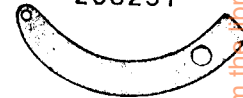
203254



200600



203251



200984



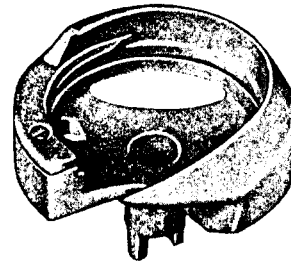
200616



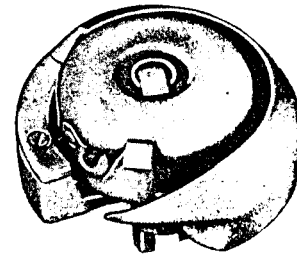
200594



203240



203290



From the Library of: Diamond Needle Corp

PLATE 12309 - FULL SIZE

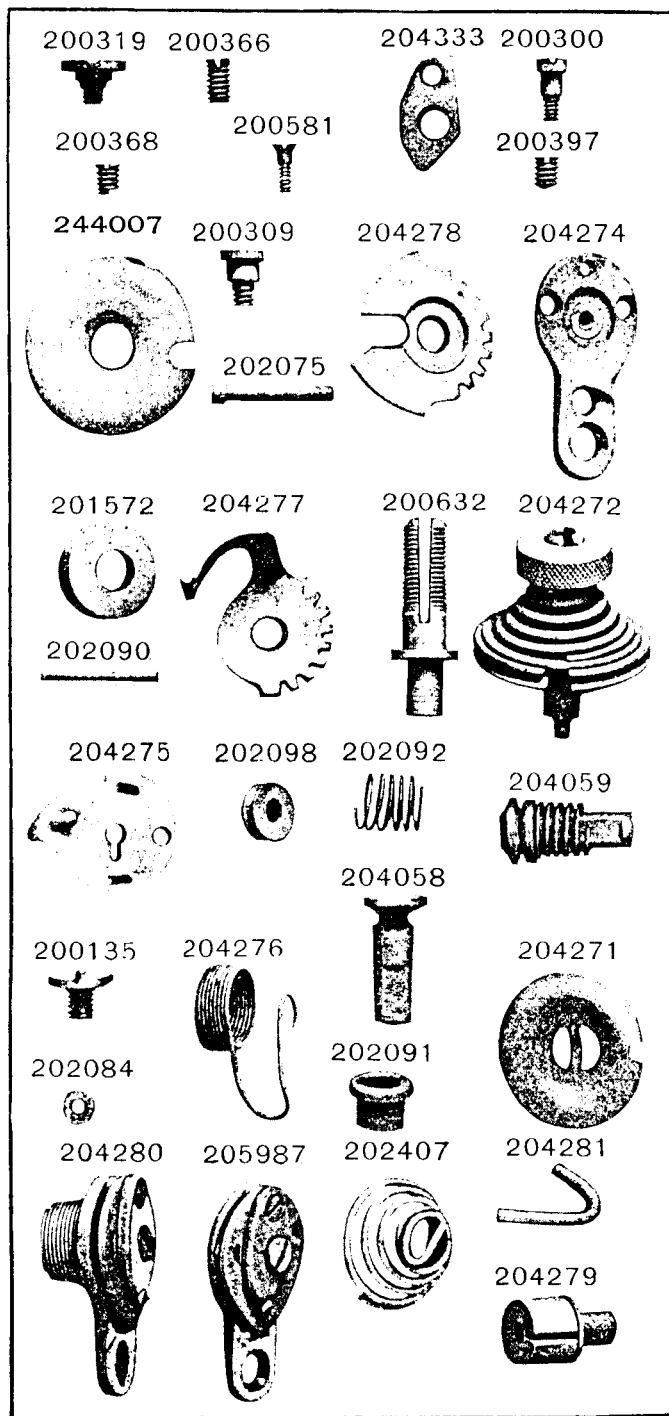
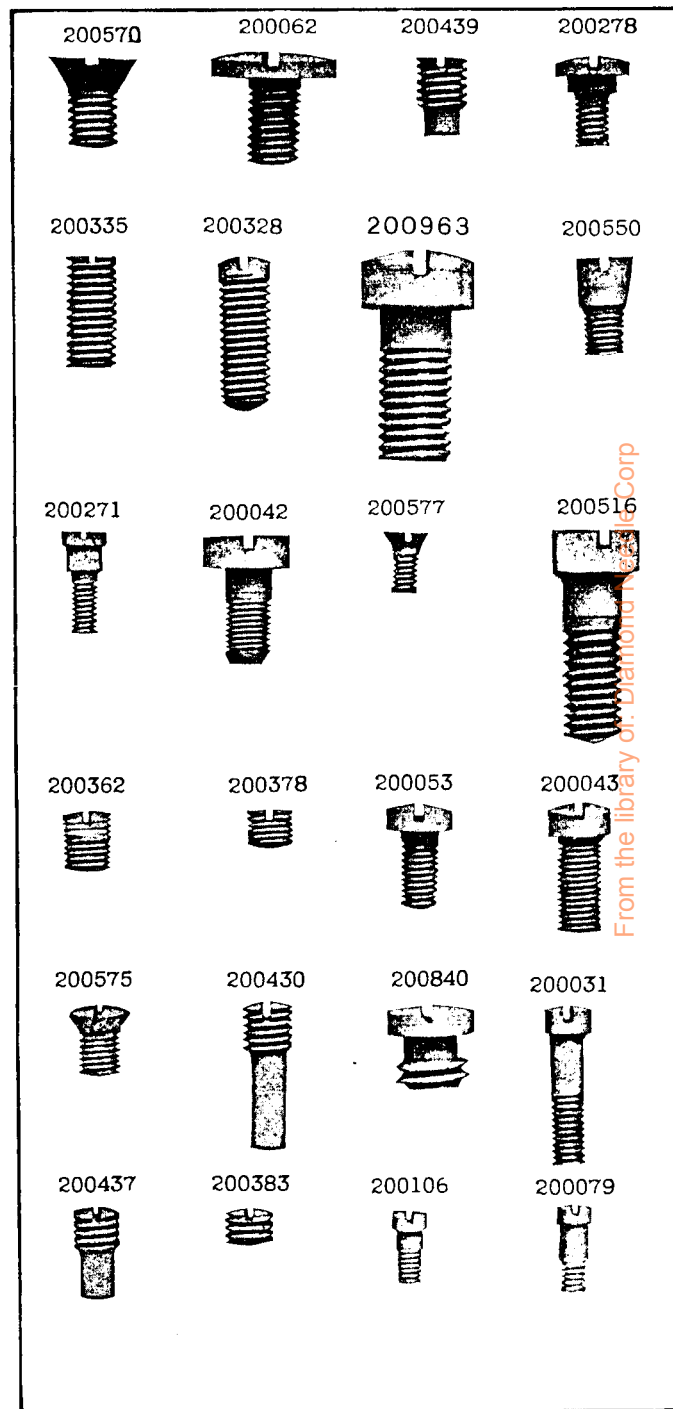


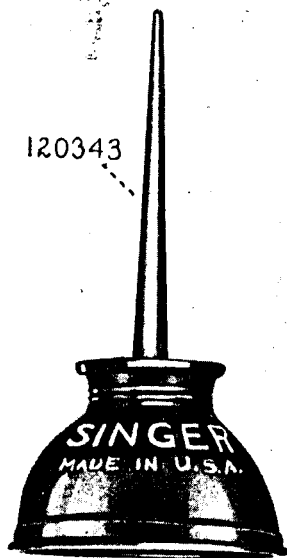
PLATE 12311 - FULL SIZE



From the library of: Diamond Tool & Die Corp

PLATE 14154—ONE-HALF SIZE

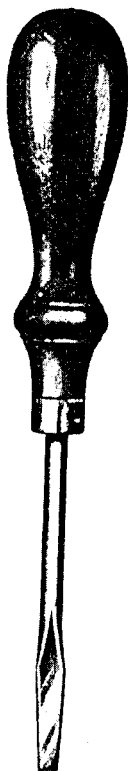
120342



225497



225498



41401



225554

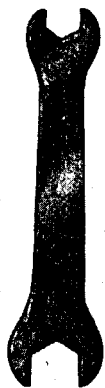


PLATE 15213—FULL SIZE

202248



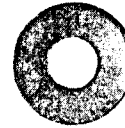
202005



200502



202622



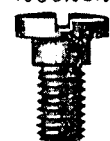
204235



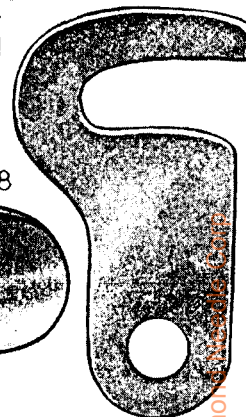
200030



200262



203184



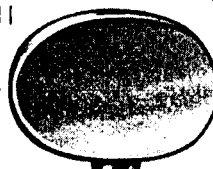
200338



203211



200728



203212



200341



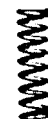
204185



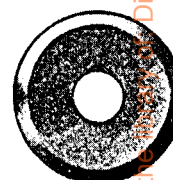
202036



203213



203185



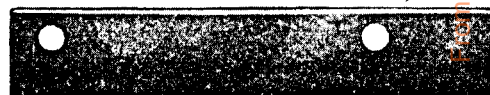
200352



200582



213685



200054



213686



222404



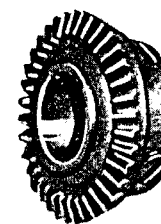
203549



200556



213319



200100

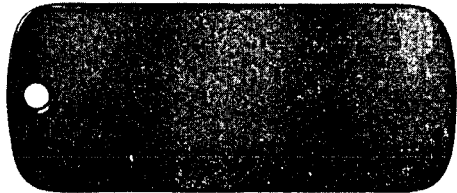


200574

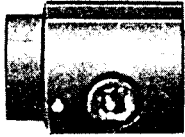


PLATE 15214—ONE-HALF SIZE

213144



213781



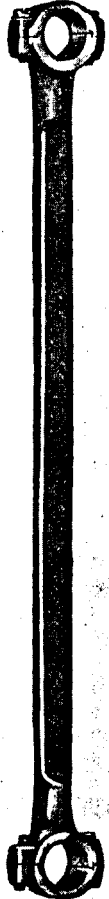
213299



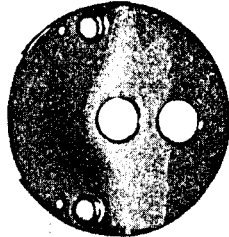
204801



204804



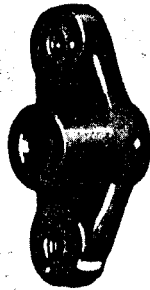
221188



213338



213314

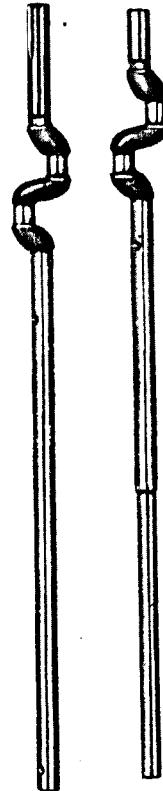


213380

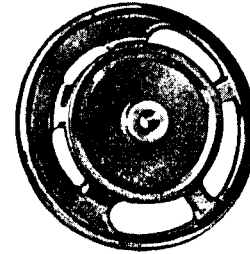


PLATE 15215—ONE-FOURTH SIZE

213341 221172



204805



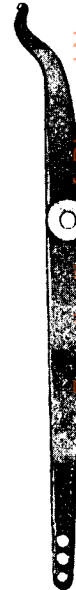
204184



202618



202781



From the Library of: Diamond Needs Corp

PLATE 15216—ONE-HALF SIZE

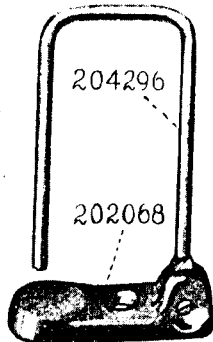
208613



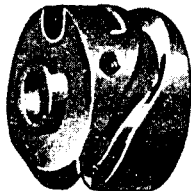
204251



204297



212920



203552



221145

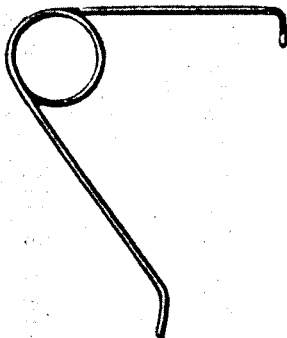
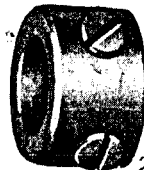


PLATE 15217—FULL SIZE

204246



203244



225837



204248



204249



200383



200504



200386



200072



202126



200503

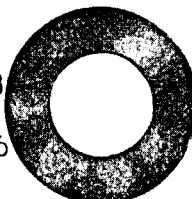


204262

201461



203172



204264



201519



200393



201816



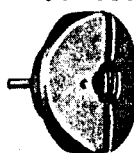
202090



201376



204263



201253



200541



204267



200835



204250



200688



200658



200125



206608



200175



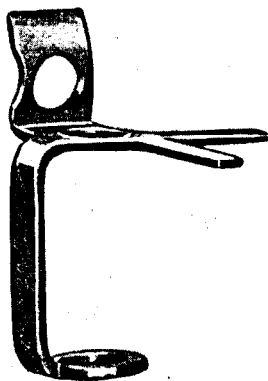
204273



From the library of: Diamond Needle Corp

PLATE 15218—FULL SIZE

208489



200684



202084



221194



221193



202413



200380



200355



204925



204033

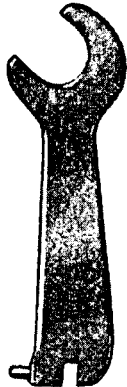
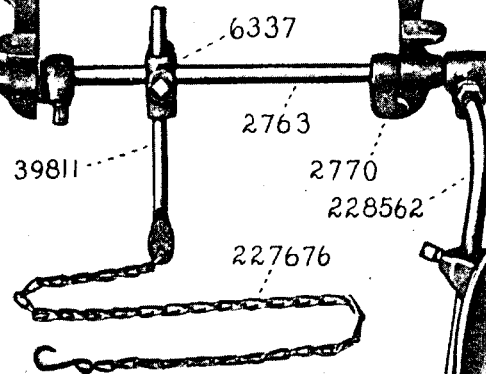


PLATE 15219—ONE-FOURTH SIZE

12242



228251



21327

6337

2763

39811

2770

228562

227676

2767

FULL SIZE

227626



1507



202784



39576



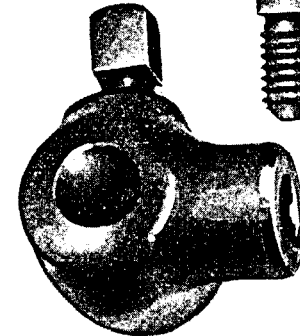
228255



356



2766



From Laboratory of Standard Needle Corp